

# Mobile Emergency Clinics



**Rotary Club  
Lviv International.**

# Project presentation

Emergency help to the war zone



## Mobile Emergency Hospitals

To remedy the problem of bombed / destroyed hospitals in eastern Ukraine. In many areas close to the front, the health service has collapsed as the local health care services are destroyed.

To remedy this, **mobile emergency clinics** are being produced that will act as mobile emergency room for injured people.

Those clinics are not intended to handle complicated operations, but minor injuries.

An estimated **80% of the injured will be able to be treated in the clinics.**



SERVE TO CHANGE LIVES



# Project presentation

The mobile hospital

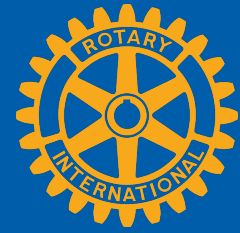

## Project design

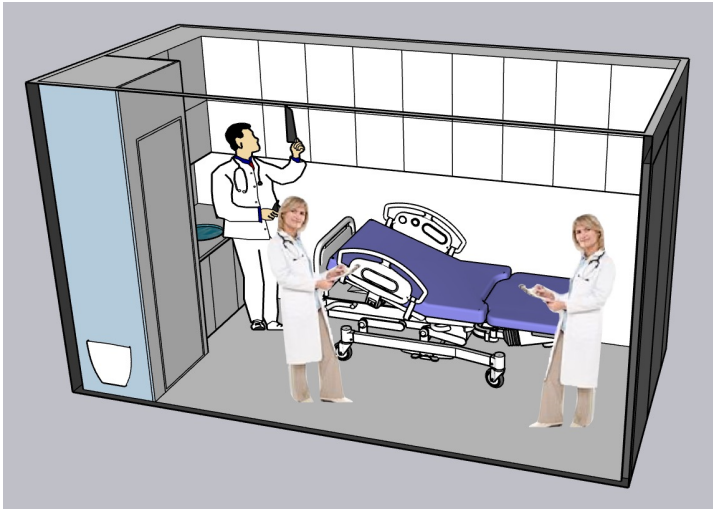

SERVE TO CHANGE LIVES

*"The units will be multi-functual to take victims from the war both as injured and women who has been a victim of abuse, etc."*

*"Normal check up on health can be done in the units."*

*"Supporting the community with clean drinking water."*



# Project presentation

The mobile hospital

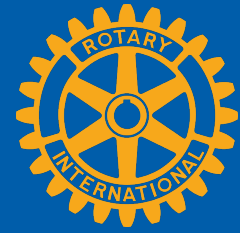

Designed to stay directly in the war zone



SERVE TO CHANGE LIVES

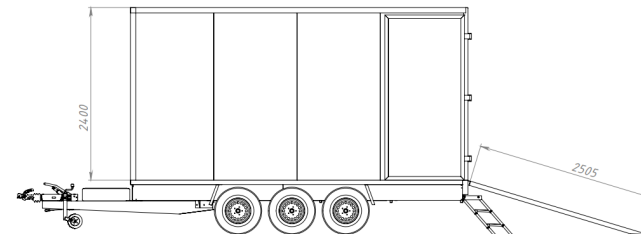
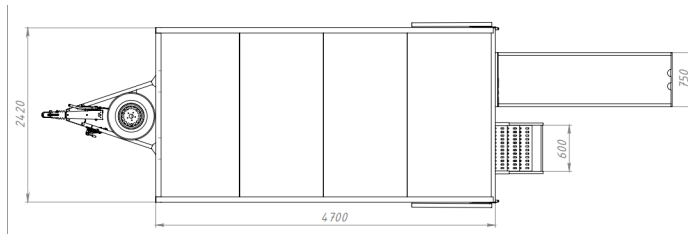
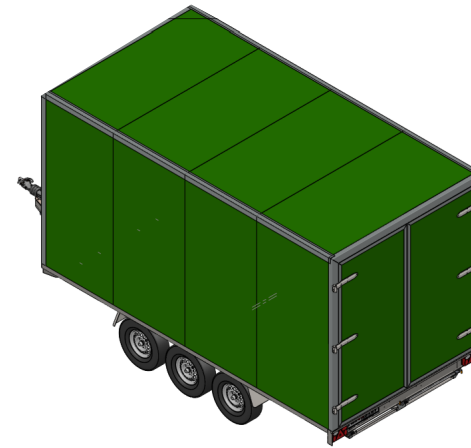
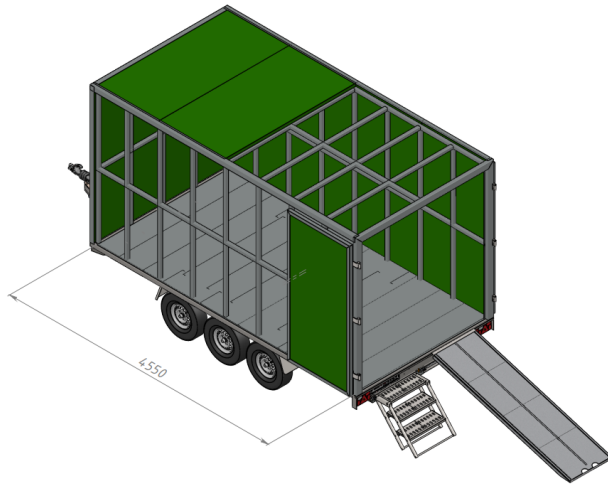

- Strong metal construction to take a small blast nearby (bombing area).
- Fire resistant 50 mm isolated walls for summer and winter use.
- Special anker system to keep the unit steady.

# Project presentation

Emergency help to the war zone

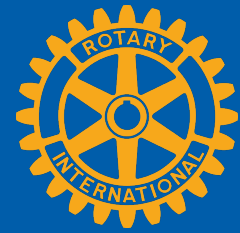

## Investment.

1 Mobile Emergency Clinic fully equipped to treat lighter injuries and smaller operation on the spot.

Price: 35.000\$



SERVE TO CHANGE LIVES

## 2 types of funding for 2 Mobile Clinics

### 2 Mobile Emergency Clinics project

Global Grant funding	USD
<b>Host Rotary Club</b>	
- RC Lviv International, Ukraine	1,000
<b>International partner Rotary club</b>	
- RC US	1,000
<b>Rotary District</b>	
- RD US	37,800
- WF match 80% from DDF	30,240
<b>Total Global Grant funding</b>	<b>70,040</b>

### 2 Mobile Emergency Clinics project

Rotary disaster funding	USD
<b>Host Rotary Club</b>	
- RC Lviv International, Ukraine	
<b>International partner Rotary club</b>	
<b>Rotary District</b>	
RD 1 commitment and The Rotary Foundation pays all funds	25,000
RD 2 commitment and The Rotary Foundation pays all funds	25,000
RD 3 commitment and The Rotary Foundation pays all funds	25,000
<b>Total Global Grant funding</b>	<b>75,000</b>

1) Global Grant funding

2) Rotary Disaster funding  
(\*TRF pays all funds\*)

# Project presentation

Emergency help to the war zone



SERVE TO CHANGE LIVES

## Timeline - Mobile Emergency Hospitals.



**Delivery time:** 45 days after payment.

## Basic Equipment installed:

- 7,5 kW generator support to ensure full 24/7 operation.
- Fully operational electric system with backup.
- Water cleaning system\* to provide clean drinking water to population in the area.
- Emergency hospital equipment is used up to 10 years old.

# We need your donations

Emergency help to the war zone



## Proposed Equipment for medical clinics:

- Table for examination of the patient
- Cardiograph
- Portable Ultrasound
- Otoscope
- Tonometers
- Tablet medicines
- Analyzers for blood, sugar levels, etc.
- Various tests (coding, hepatitis, HIV / AIDS)
- Phonendoscopes
- Surgical kit
- If possible, a dental chair



SERVE TO CHANGE LIVES

**PLEASE DONATE**

# We need your help

Emergency help to the war zone

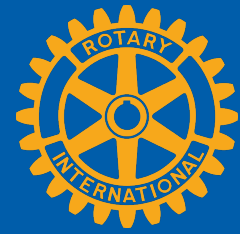

**Jakob Dalhoff**

General Director  
MatchOffice

Member of  
Rotary Club Lviv International

MsC Finance & Accounting

Paul Harris Fellow  
Community member in Rotary

Professor in Startups, Lviv  
Polytechnic National University

[jd@lokalebasen.dk](mailto:jd@lokalebasen.dk)  
+380 (63) 216 26 12



**Lars Vestbjerg**

President  
Danish Business Association

Board Member of  
Rotary Club Lviv International

Paul Harris Fellow  
Community member in Rotary

[lars@vestbjerg.com](mailto:lars@vestbjerg.com)  
+380 (67) 674 68 66



SERVE TO CHANGE LIVES